

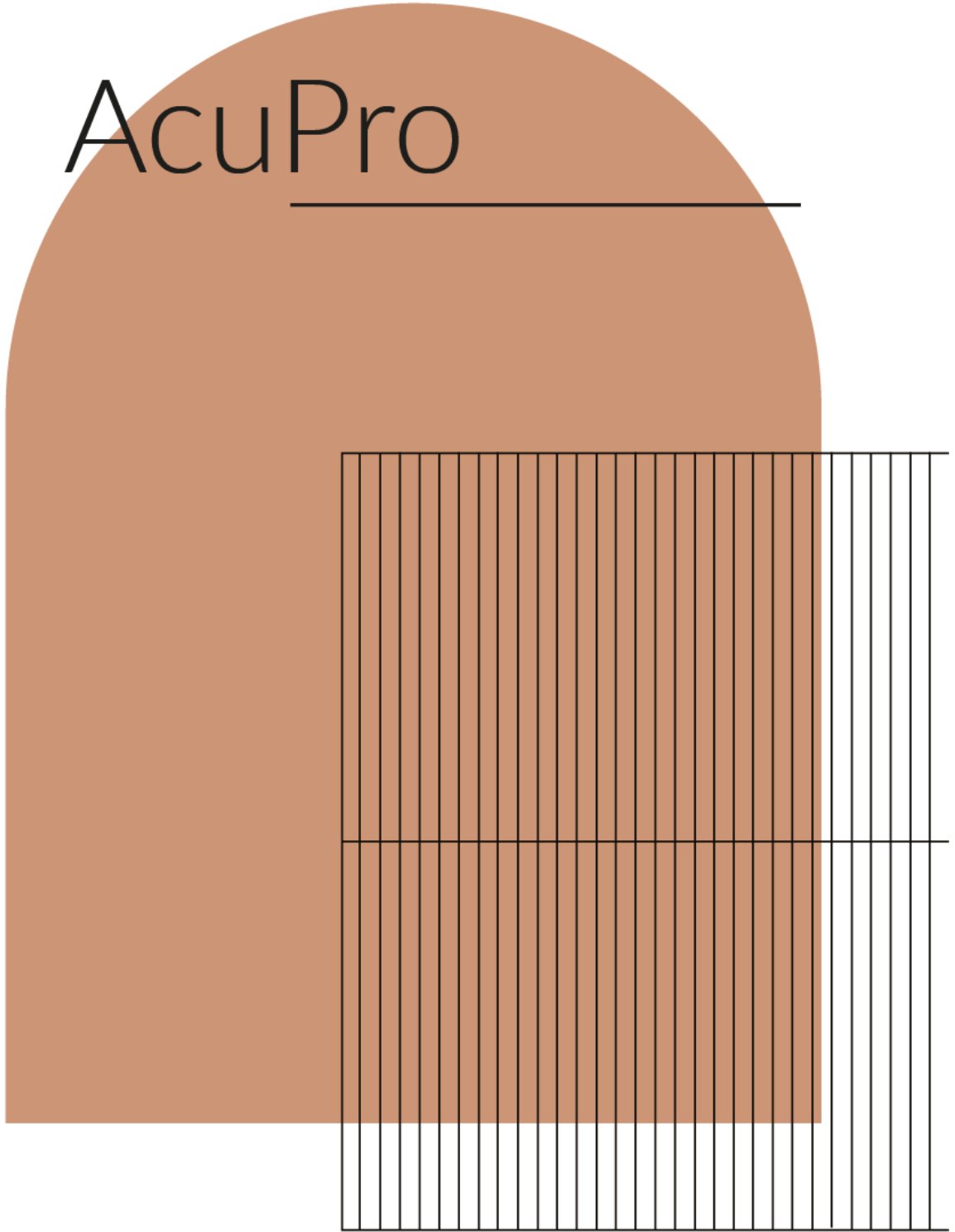

AcuPro

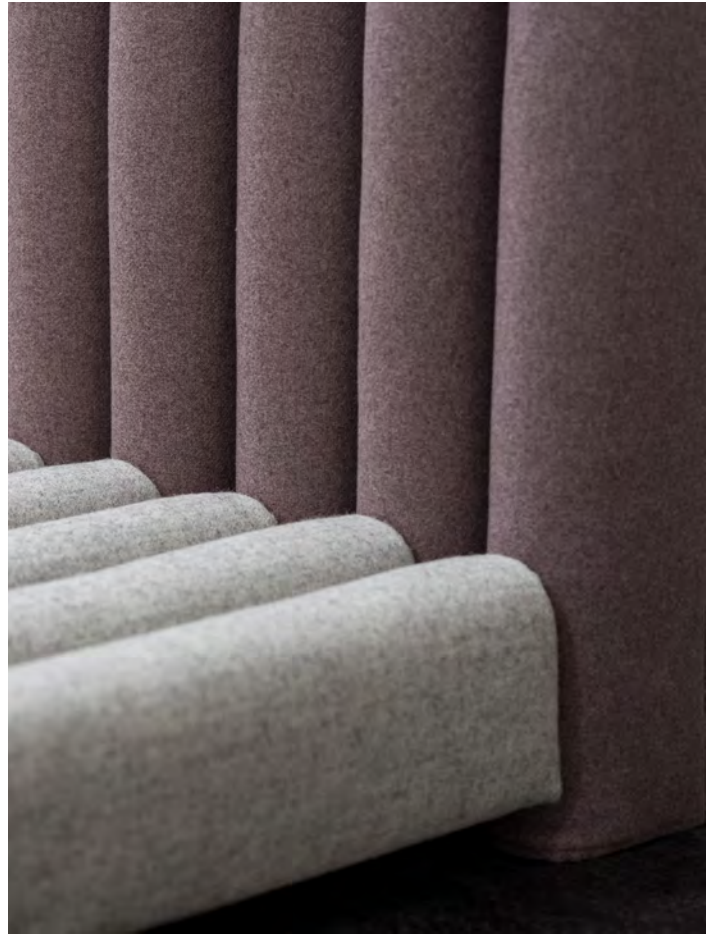



MARO Office Furniture

For 30 years, we have been making sure that office work is comfortable and ergonomic. Our furniture demonstrates our professionalism and love for what we do. We are passionate about creating exquisite and functional things and that translates into a quest for new solutions that turn concepts into products at a higher and higher level. Using innovative engineering solutions, we strive for ensuring that our products are top-notch. Our quality has been proved by ISO 9001 and Geprüfte Sicherheit certificates. This is possible thanks to our technology park, where world-class techniques come together under one roof. As a responsible producer, we wish to minimize our ecological footprint and expect the same from our suppliers.

Our Machinery Park guarantees top quality and precision. Thanks to the investments in new techniques and constant search for unconventional solutions, we thrive all the time. We are aware of how valuable the human factor is, therefore some elements of our furniture are hand-made. Gluing the carcasses of curved counters is a job where the human has an advantage over the machine. However, where surgical precision and repeatability in short time are necessary, we take advantage of the latest technique. Wood processing center drills, mills and processes the edges with utmost precision. The quality of our furniture is based on hundreds of trials and tests, thanks to which we are certain that we are second to none



AcuPro

TRANSPORT

- Product delivered in boxes
- Self-assembly

WARRANTY

- 5-year MARO warranty

SOUND ABSORPTION CLASS

- Class A.

CERTIFICATES



MELAMINE PANEL BOARD CERTIFICATES



DESIGNER

STUDIO RYGALIK

Sustainable development

Find out more about our activity.



<https://maro.pl/en/company/sustainable-development>

AcuPro

by Studio Rygalik

STRUCTURE

- Chipboard coated on both sides with melamine resin with increased durability - 1st class.
- Chipboard with reduced formaldehyde emission, E1 standard.
- Frame made of 30x30 mm powder-coated metal profiles.
- Upholstered elements made of recycled foam.

ACOUSTIC PROPERTIES

- Sound absorption class - **A** according **PN-EN ISO 354:2005**
- Sound absorption coefficient (α_w) - 1,00

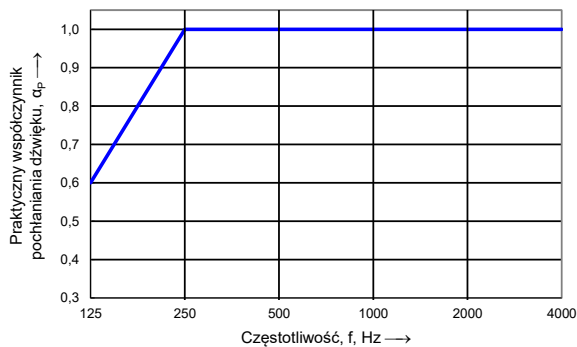
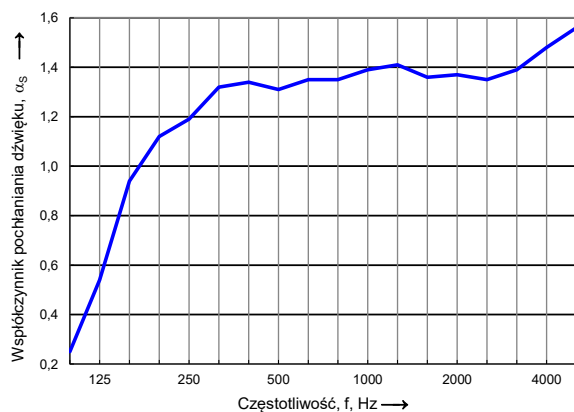

AcuPro wall absorber

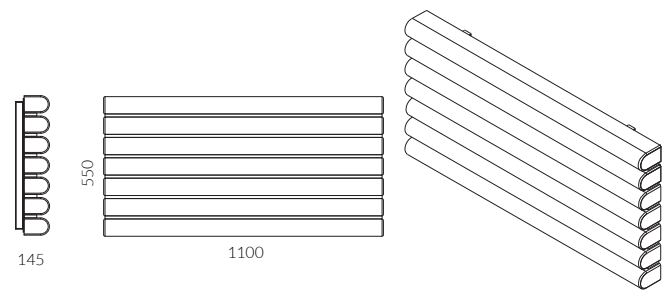

AcuPro extension module

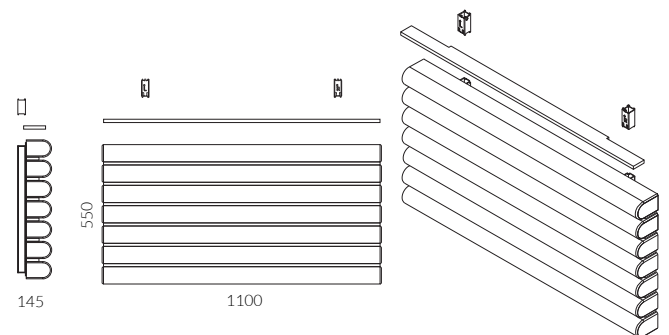

AcuPro shelf

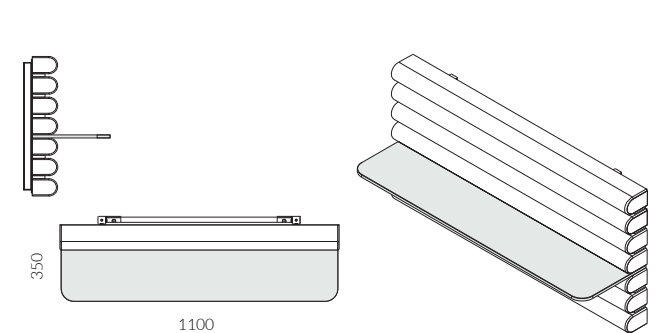

EQUIPMENT

- If a few absorbers are joined, an extra extension module needs to be ordered. It is delivered with metal, powder-coated elements that join the profiles of the absorbers and a felt insert that fills the gap between the upholstered elements.
- Shelf made of 12 mm thick melamine board as an option. Max. load: 5 Kg.

ADDITIONAL INFORMATION

- The right choice of mounting system for a given surface is up to the client.
- Colors according to MARO offer

Acoustics / Colors

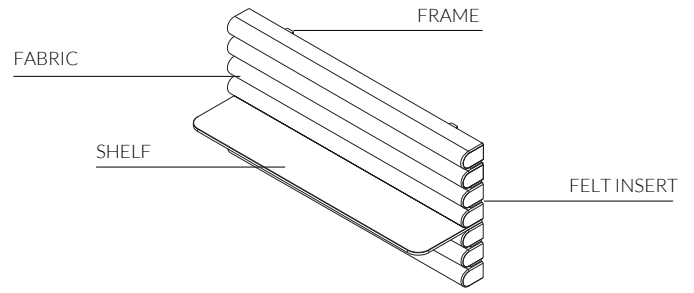

			Fabric	CubiSound frame	AcuPro frame	Felt insert	AcuPro 8 mm shelf
1ST GROUP	Caldo	LC1	•				
		LC2	•				
		LC5	•				
		LC6	•				
		LC11	•				
		LC13	•				
		LC14	•				
		LC16	•				
		LC17	•				
		LC19	•				
	LT4	•					
	Terra	LT5	•				
		LT10	•				
		LT14	•				
LT3		•					
2ND GROUP	Synergy	CS45	•				
		CS44	•				
		CS46	•				
		CS49	•				
		CS56	•				
		CS74	•				
		CS73	•				
		CS79	•				
		CS59	•				
		CS62	•				
		CS08	•				
		CS16	•				
		3RD GROUP	Synergy Quilt	CSI08			
CSV08							
CSI59							
CSV59							
STANDARD	Metal	M02 White			•		
		M01 Aluminium			•		
		M03 Beige			•		
		M05 Graphite			•		
		M04 Black		•	•		
TREND*	Metal	M06 Sunny Beige					
		M09 Dirty Pink					
		M08 Ginger					
		M07 Faded Turquoise					
	Felt	Antracite				•	
Melamine resin		STD 1 White					•
		STD 7 Graphite					•

Melamine

① STANDARD

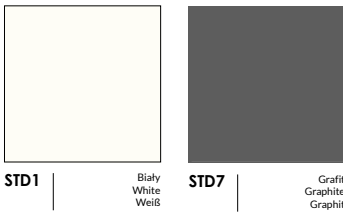

Metal

① STANDARD



Fabrics

100% Polyester
100.000 Martindale cycles

① CALDO
Select by Lech

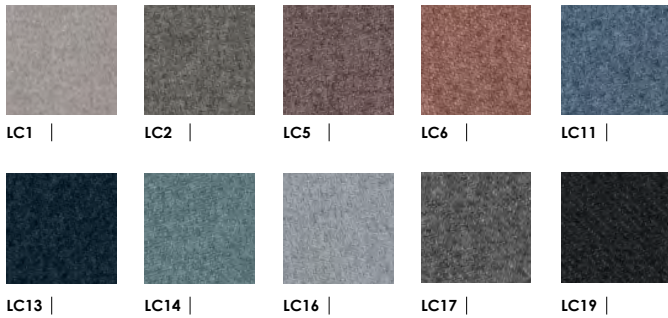

95% Virgin Wool, 5% Poliamid
100.000 Martindale cycles

② SYNERGY
Camira

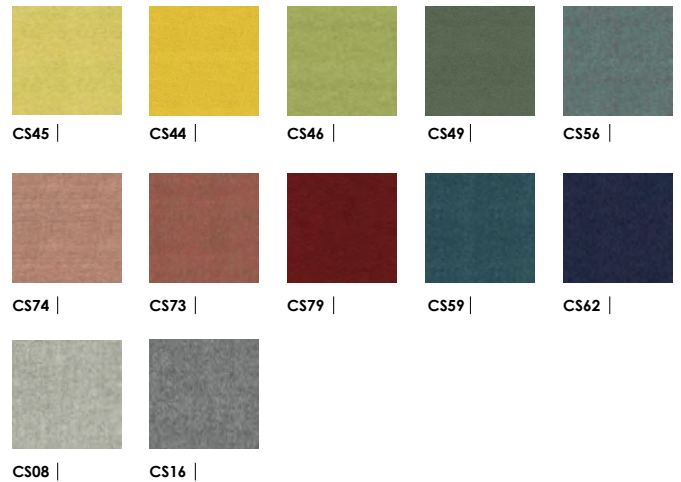

100% Recycled Polyester
67.000 Martindale cycles

① TERRA
Select by Lech

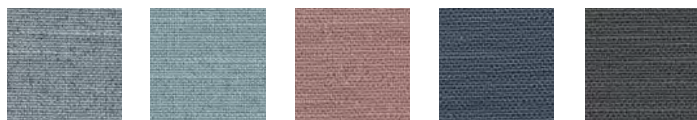

Information

You can find all our current materials online.

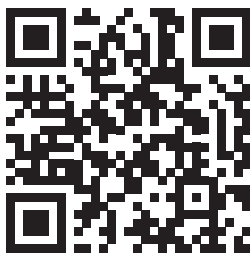

Visit our website maro.pl

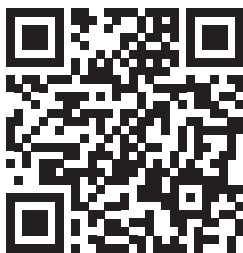

Find high quality photos and films to use in your materials
maro.cloud/photo

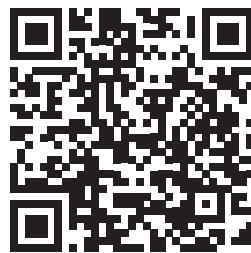

Find solids and catalogs
maro.pl/design-tools/pliki-do-pobrania



Order furniture online
shop.maro.pl



Fabryka Mebli Biurowych MARO Sp. z o. o.
PL 62-052 Komorniki, ul. Fabianowska 100

+48 61 890 00 00

maro@maro.pl

MARO.pl

Follow us and join t o MARO community

 [/@maroofficefurniture](https://www.linkedin.com/company/maroofficefurniture)

 [/@maroofficefurniture](https://www.facebook.com/maroofficefurniture)

 [/@maroofficefurniture](https://www.instagram.com/maroofficefurniture)

 [/@maroofficefurniture](https://www.youtube.com/maroofficefurniture)

Please place your orders for printed materials and color samples by e-mail t o marketing@maro.pl.

Illustrations presented in this publication are only illustrative and do not constitute any offer or guarantee of any form - it especially applies to presented color and furniture surfaces used by MARO Office Furniture Factory. Please contact MARO sp. z o. o. to obtain information on functions and configurations.

All presented data, especially photos, specifications, descriptions, drawings and technical parameters do not constitute an offer in legal terms of the Civil Code, are not binding and can be changed without prior notice. A Sales Contract contains bidding prices, equipment and specifications.

We reserve the right to make changes and mistakes. All the information in this price list is up-to-date on the publication date/accepting the material for publishing. The prices do not include VAT tax.

General Terms and Conditions of Sales and General Warranty and Complaint Terms and Conditions constitute an integral part of Sales Contracts.

The price list is valid from 01.07.2022 until further notice.