



**Executive desks Toris**



## MARO Office Furniture

---

For 30 years, we have been making sure that office work is comfortable and ergonomic. Our furniture demonstrates our professionalism and love for what we do. We are passionate about creating exquisite and functional things and that translates into a quest for new solutions that turn concepts into products at a higher and higher level. Using innovative engineering solutions, we strive for ensuring that our products are top-notch. Our quality has been proved by ISO 9001 and Geprüfte Sicherheit certificates. This is possible thanks to our technology park, where world-class techniques come together under one roof. As a responsible producer, we wish to minimize our ecological footprint and expect the same from our suppliers.

Our Machinery Park guarantees top quality and precision. Thanks to the investments in new techniques and constant search for unconventional solutions, we thrive all the time. We are aware of how valuable the human factor is, therefore some elements of our furniture are hand-made. Gluing the carcasses of curved counters is a job where the human has an advantage over the machine. However, where surgical precision and repeatability in short time are necessary, we take advantage of the latest technique. Wood processing center drills, mills and processes the edges with utmost precision. The quality of our furniture is based on hundreds of trials and tests, thanks to which we are certain that we are second to none



## Executive desks Toris

---

### TRANSPORT

- Product delivered in boxes
- Self-assembly

### WARRANTY

- 5-year MARO warranty
- Product delivered in boxes
- Self-assembly

### Accessories Toris



### CERTIFICATES



### MELAMINE PANEL BOARD CERTIFICATES



---

## Sustainable development

Find out more about our activity.



[maro.pl/firma/zrownowazony-rozwoj](http://maro.pl/firma/zrownowazony-rozwoj)

# Toris

Toris is a collection of furniture with geometrical, simple form. It features executive desks, conference and occasional tables.

Executive desks can be supported on pedestals, sideboards or executive add-on tables. It is also possible to match two different colors/decors for the inner and outer sides of board legs and top.

---

## TOP

- Chipboard coated on both sides with melamine resin with increased durability - 1st class.
- Chipboard with reduced formaldehyde emission, E1 standard.
- Top finished with 2 mm thick ABS plastic edge with 3 mm radius.
- Decorative slat made of brushed aluminum between the top and panel leg.
- Internal part of the desk can be different color/ decor than the external part.



## ADDITIONAL INFORMATION

- Colors according to MARO

## FRAME

- Steel structure comprising of welded elements ensuring rigidity.
- 36 mm thick board legs affixed to the top as standard.



## WYPOSAŻENIE DODATKOWE

- Horizontal cable management: powder-coated fixed or fold-down cable channel affixed under the top as standard, plastic cable clasp.
- Vertical cable management: flexible, plastic, two-piece, metal cable channel, cable outlets and netboxes.

Executive desk

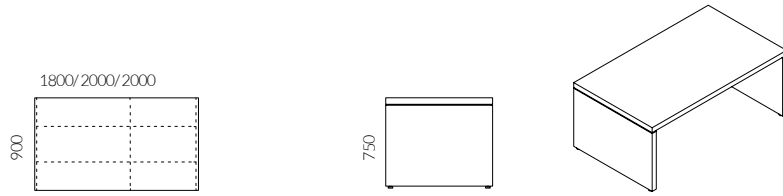

Add-on unit for executive desks

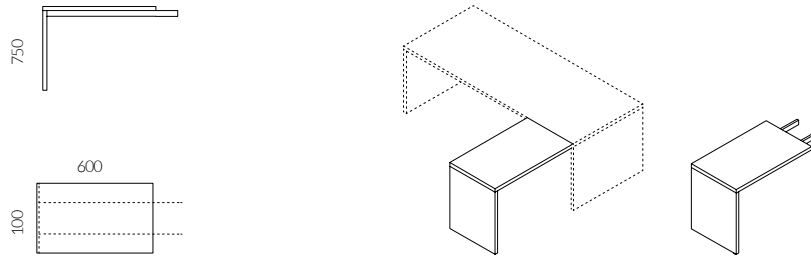

Executive desk for support

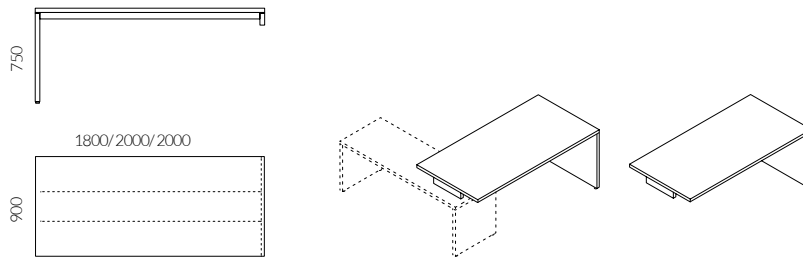

Add-on desk for executive desk support

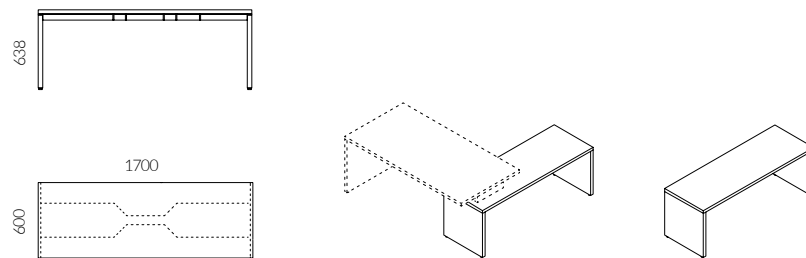

Board modesty panel for executive desks

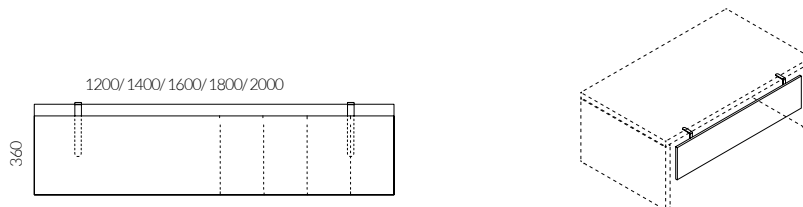

# Toris / Features

## Cladding

The structure of Toris furniture enables to use different colors on the external and internal side of the furniture.

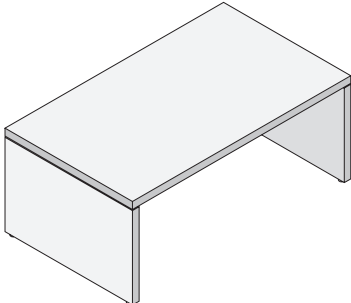

## Decorative slat

Decorative slat made of brushed aluminum between the top and panel leg.

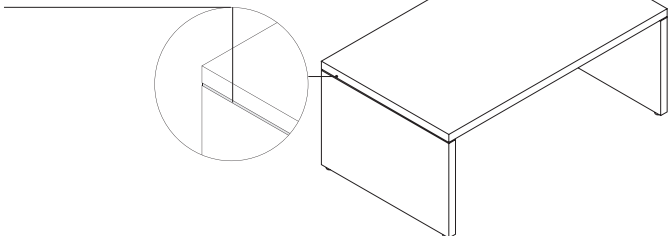

## Graining

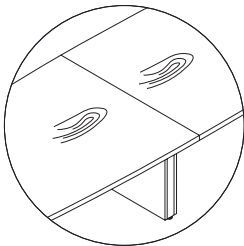

In two-piece tops continuous graining as standard. Minor displacement possible.

## Cable channel in conference table leg

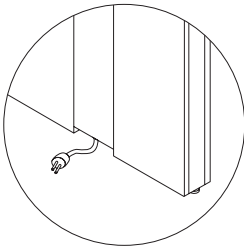

The leg of Toris conference table is equipped with a board cable channel.

## Desk supported on sideboard

The hinged door segment of the executive desk supported on sideboard can be accessed from both sides. There are four door mounting options.

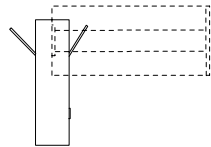
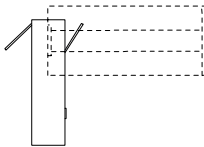
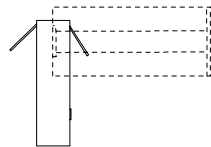
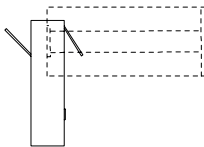
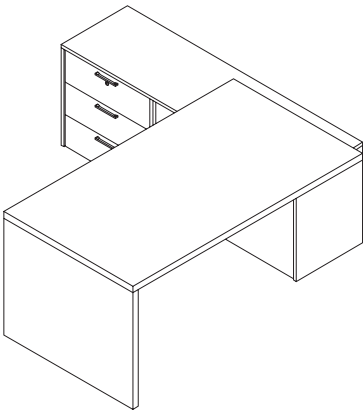



# Melamine

① STANDARD



② TREND



# Metals

① STANDARD



② TREND

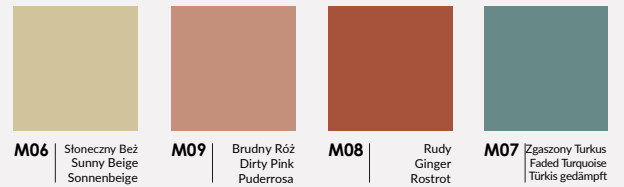

# Fabrics

100% Polyester  
100.000 Martindale cycles

① CALDO  
Select by Lech

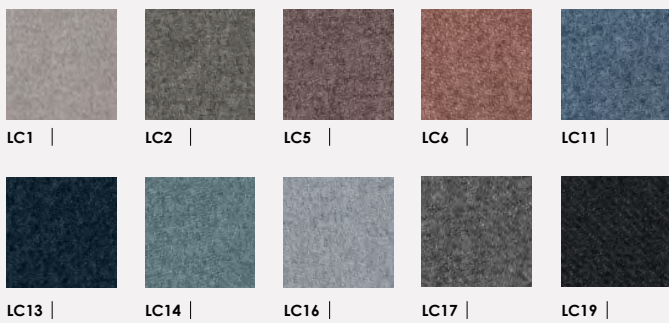

100% Recycled Polyester  
67.000 Martindale cycles

① TERRA  
Select by Lech



95% Virgin Wool, 5% Poliamid  
100.000 Martindale cycles

② SYNERGY  
Camira

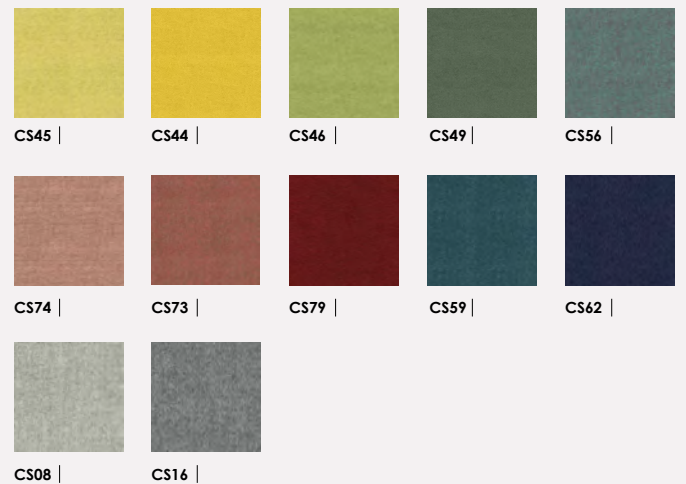



## Information

---

You can find all our current materials online.

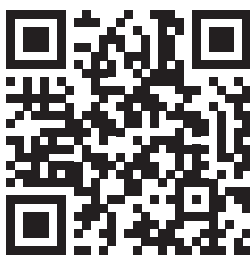

Visit our website [maro.pl](http://maro.pl)

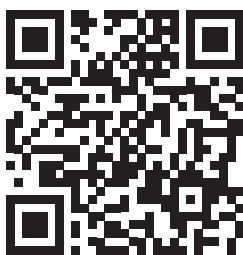

Find high quality photos and films to use in your materials  
[maro.cloud/photo](http://maro.cloud/photo)



Find solids and catalogs  
[maro.pl/design-tools/pliki-do-pobrania](http://maro.pl/design-tools/pliki-do-pobrania)



Order furniture online  
[shop.maro.pl](http://shop.maro.pl)



Fabryka Mebli Biurowych MARO Sp. z o. o.  
PL 62-052 Komorniki, ul. Fabianowska 100

+48 61 890 00 00

[maro@maro.pl](mailto:maro@maro.pl)

**ARO**

## Follow us and join t o MARO community

 /@maroofficefurniture

 /@maroofficefurniture

 /@maroofficefurniture

 /@maroofficefurniture

Please place your orders for printed materials and color samples by e-mail to [marketing@maro.pl](mailto:marketing@maro.pl).

Illustrations presented in this publication are only illustrative and do not constitute any offer or guarantee of any form - it especially applies to presented color and furniture surfaces used by MARO Office Furniture Factory. Please contact MARO sp. z o. o. to obtain information on functions and configurations.

All presented data, especially photos, specifications, descriptions, drawings and technical parameters do not constitute an offer in legal terms of the Civil Code, are not binding and can be changed without prior notice. A Sales Contract contains bidding prices, equipment and specifications.

We reserve the right to make changes and mistakes. All the information in this price list is up-to-date on the publication date/accepting the material for publishing. The prices do not include VAT tax.

General Terms and Conditions of Sales and General Warranty and Complaint Terms and Conditions constitute an integral part of Sales Contracts.

The price list is valid from 01.10.2022 until further notice.