



I-eM seminar tables



MARO Office Furniture

For 30 years, we have been making sure that office work is comfortable and ergonomic. Our furniture demonstrates our professionalism and love for what we do. We are passionate about creating exquisite and functional things and that translates into a quest for new solutions that turn concepts into products at a higher and higher level. Using innovative engineering solutions, we strive for ensuring that our products are top-notch. Our quality has been proved by ISO 9001 and Geprüfte Sicherheit certificates. This is possible thanks to our technology park, where world-class techniques come together under one roof. As a responsible producer, we wish to minimize our ecological footprint and expect the same from our suppliers.

Our Machinery Park guarantees top quality and precision. Thanks to the investments in new techniques and constant search for unconventional solutions, we thrive all the time. We are aware of how valuable the human factor is, therefore some elements of our furniture are hand-made. Gluing the carcasses of curved counters is a job where the human has an advantage over the machine. However, where surgical precision and repeatability in short time are necessary, we take advantage of the latest technique. Wood processing center drills, mills and processes the edges with utmost precision. The quality of our furniture is based on hundreds of trials and tests, thanks to which we are certain that we are second to none



I-eM seminar tables

TRANSPORT

- Product delivered in boxes
- Self-assembly

WARRANTY

- 5-year MARO warranty

Accessories SYSTEM eM



CERTIFICATES



MELAMINE PANEL BOARD CERTIFICATES



Sustainable development

Find out more about our activity.



maro.pl/firma/zrownowazony-rozwoj

System-eM

System-eM is a collection of modular furniture which features rectangular desks, desks with tops of different shapes, team desks - Bench desks with electric height adjustment - individual and multi-person workstations and simple conference tables with different tops.

System-eM offers seven leg modules - on four straight legs with round and square cross-section, on four A- and Q-shaped legs with rectangular cross-section, and rectangular, recessed legs -F model.

The collection is completed with Lano C and Lano T modules which have two legs with square cross-section placed on a foot. The desks can also be equipped with different accessories such as upholstered, chipboard partition screens, netboxes and cable channels, as well as underdesk sideboards that support the desk.

TOP

- Chipboard coated on both sides with melamine resin with increased durability - 1st class.
- Chipboard with reduced formaldehyde emission, E1 standard.
- Top finished with 2 mm thick ABS plastic edge with 3 mm radius.
- Chipboard tops 25 mm thick as standard.
- Clips for joining tables - 2pcs., screws - 4 pcs. as standard.
- Optional round rubber finish that serves as a bumper.

STRAIGHT EDGE CORNER*

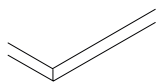

* Standard

RUBBER EDGE CORNER

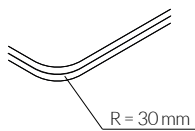

R = 30 mm



FRAME

- Based on legs with a round cross-section \varnothing 60 mm.
- Self-supporting steel structure comprising of welded elements.
- Based on 4 castors, 2 castors with brakes.

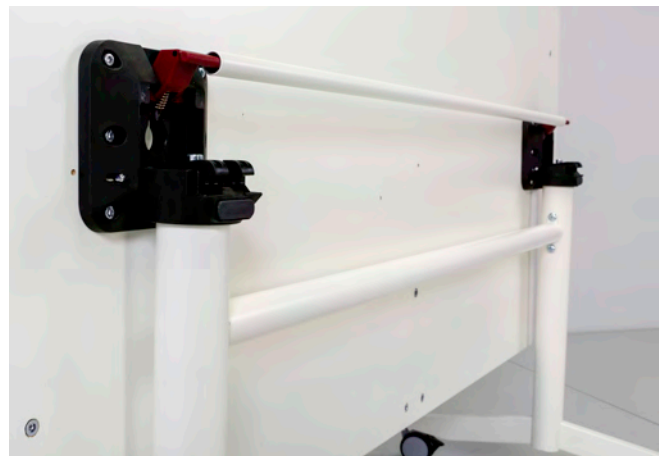

HEIGHT

- Fixed height 740 mm and leveling feet +10 mm.

ADDITIONAL INFORMATION

- Colors according to MARO

SAMPLE LAYOUTS

- Sample arrangement possibilities of tables and chairs.

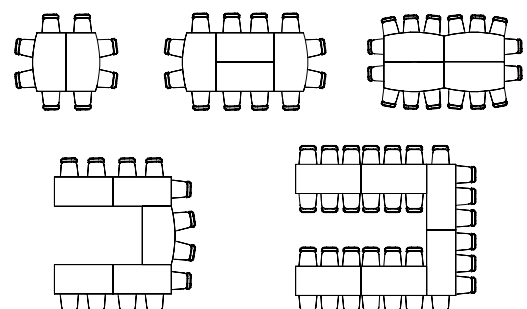

I-eM rectangular top

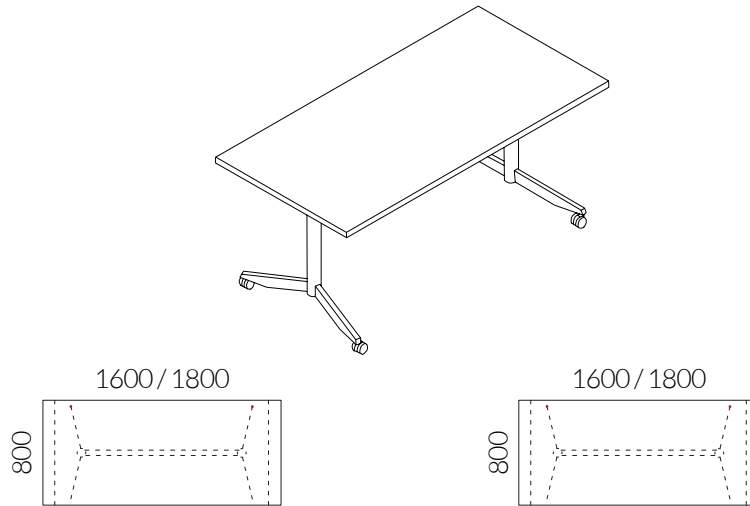

I-eM shaped table

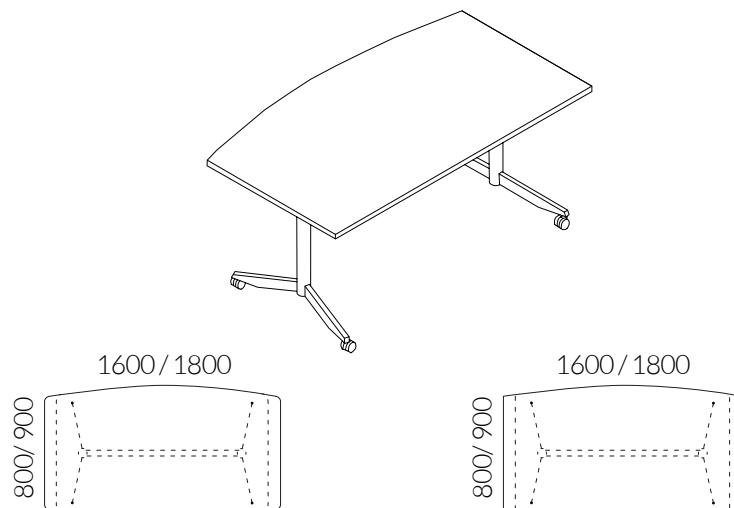

Chipboard modesty panel

Mounted under the table on hinges. Folding together with table top.

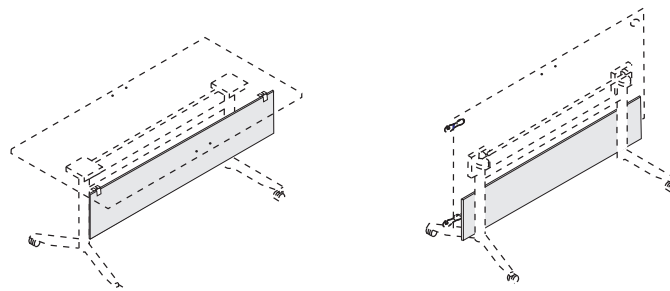

Melamine

① STANDARD



② TREND

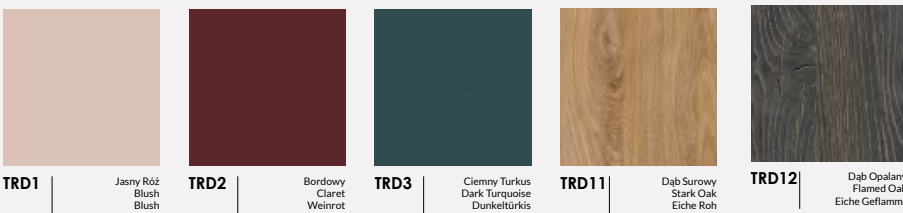

Metal

① STANDARD

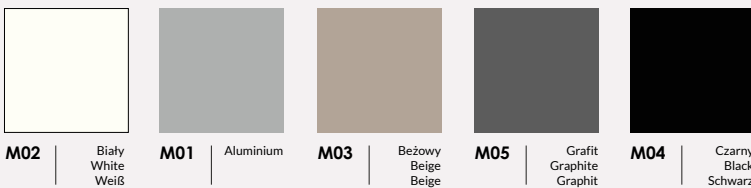

② TREND

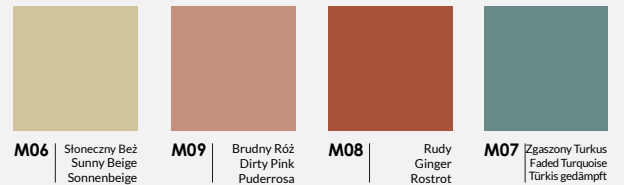

Fabrics

100% Polyester
100.000 Martindale cycles

① CALDO
Select by Lech

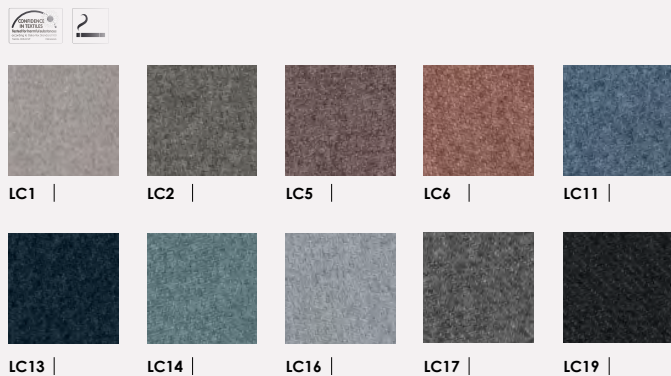

95% Virgin Wool, 5% Poliamid
100.000 Martindale cycles

② SYNERGY
Camira

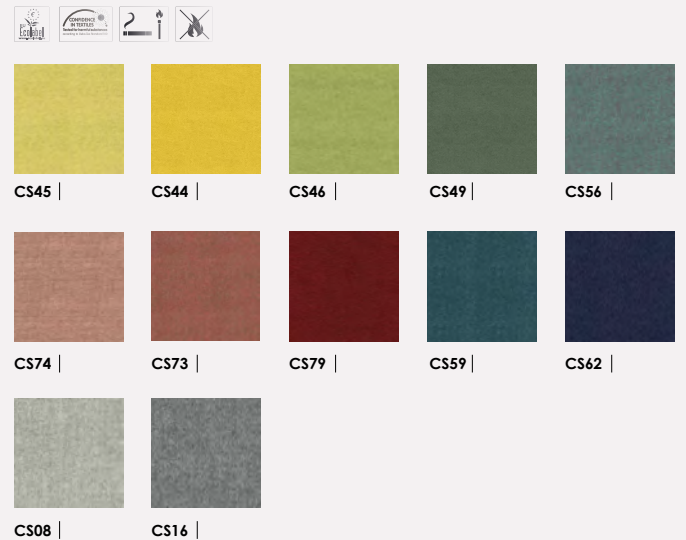

100% Recycled Polyester
67.000 Martindale cycles

① TERRA
Select by Lech



Information

You can find all our current materials online.

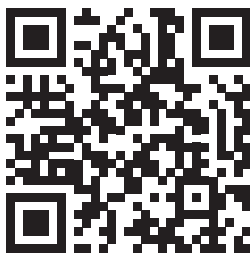

Visit our website maro.pl

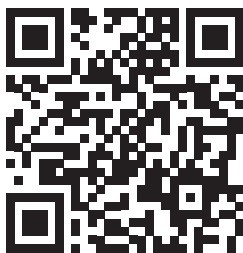

Find high quality photos and films to use in your materials
maro.cloud/photo

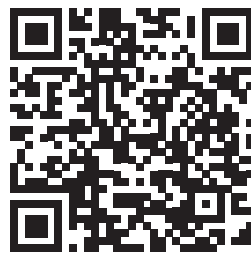

Find solids and catalogs
maro.pl/design-tools/pliki-do-pobrania



Order furniture online
shop.maro.pl



Fabryka Mebli Biurowych MARO Sp. z o. o.
PL 62-052 Komorniki, ul. Fabianowska 100

+48 61 890 00 00

maro@maro.pl

MARO.pl

Follow us and join t o MARO community

 /@maroofficefurniture

 /@maroofficefurniture

 /@maroofficefurniture

 /@maroofficefurniture

Please place your orders for printed materials and color samples by e-mail t o marketing@maro.pl.

Illustrations presented in this publication are only illustrative and do not constitute any offer or guarantee of any form - it especially applies to presented color and furniture surfaces used by MARO Office Furniture Factory. Please contact MARO sp. z o. o. to obtain information on functions and configurations.

All presented data, especially photos, specifications, descriptions, drawings and technical parameters do not constitute an offer in legal terms of the Civil Code, are not binding and can be changed without prior notice. A Sales Contract contains bidding prices, equipment and specifications.

We reserve the right to make changes and mistakes. All the information in this price list is up-to-date on the publication date/accepting the material for publishing. The prices do not include VAT tax.

General Terms and Conditions of Sales and General Warranty and Complaint Terms and Conditions constitute an integral part of Sales Contracts.

The price list is valid from 01.07.2022 until further notice.