



Cabinets and Showcases AXY-Line



MARO Office Furniture

For 30 years, we have been making sure that office work is comfortable and ergonomic. Our furniture demonstrates our professionalism and love for what we do. We are passionate about creating exquisite and functional things and that translates into a quest for new solutions that turn concepts into products at a higher and higher level. Using innovative engineering solutions, we strive for ensuring that our products are top-notch. Our quality has been proved by ISO 9001 and Geprüfte Sicherheit certificates. This is possible thanks to our technology park, where world-class techniques come together under one roof. As a responsible producer, we wish to minimize our ecological footprint and expect the same from our suppliers.

Our Machinery Park guarantees top quality and precision. Thanks to the investments in new techniques and constant search for unconventional solutions, we thrive all the time. We are aware of how valuable the human factor is, therefore some elements of our furniture are hand-made. Gluing the carcasses of curved counters is a job where the human has an advantage over the machine. However, where surgical precision and repeatability in short time are necessary, we take advantage of the latest technique. Wood processing center drills, mills and processes the edges with utmost precision. The quality of our furniture is based on hundreds of trials and tests, thanks to which we are certain that we are second to none



Cabinets and Showcases AXY-Line

TRANSPORT

- corps factory glued, assembled and delivered complete .

-WARRANTY

- 5-year MARO warranty.

CERTIFICATES



MELAMINE PANEL BOARD CERTIFICATES



Sustainable development

Find out more about our activity.



maro.pl/firma/zrownowazony-rozwoj

AXY-Line

AXY-Line is a collection of conference and executive furniture. It features both large and smaller conference tables. The tables can be based on different types of legs A-, X- and Y-shaped.

A wide range of tops and dimensions makes this collection a perfect solution for any office. Cabinets and showcases complete the collection.

Showcases

CARCASS

- 18 mm thick board carcass.
- Chipboard coated on both sides with melamine resin with increased durability - 1st class.
- Chipboard with reduced formaldehyde emission, E1 standard.
- Showcase carcasses are factory-glued, assembled and delivered as a whole.
- Carcass finished with 2 mm thick ABS plastic edge with 3 mm radius.



EQUIPMENT

- All shelves are equipped with a mechanism preventing accidental pull out.
- Possibility to manage the interior space individually thanks to hole spacing (every 32 mm) over the entire height of sides.
- Hinged doors are equipped with C1 handles as standard. Push to Open system as an option with no surcharge.
- White or graphite decorative inlay between the modules of the showcase.
- Showcases based on 200 mm high, powder-coated legs.



ADDITIONAL INFORMATION

- Colors according to MARO offer

AXY-Line narrow executive showcase

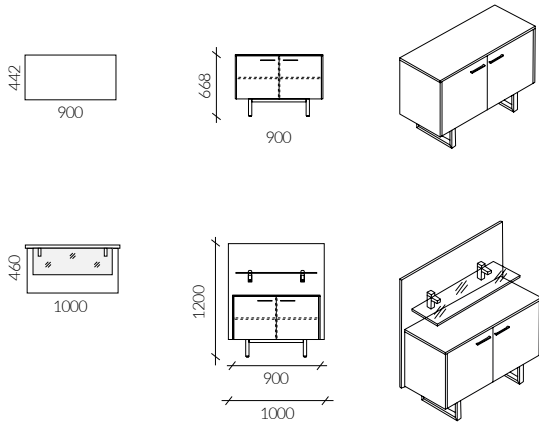

AXY-Line narrow executive showcase with open segment

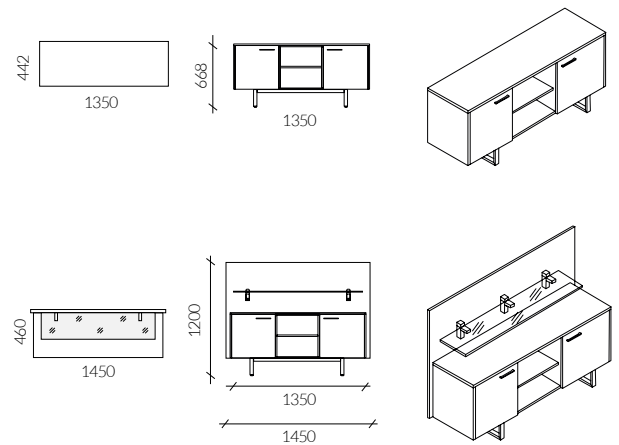

AXY-Line narrow executive showcase

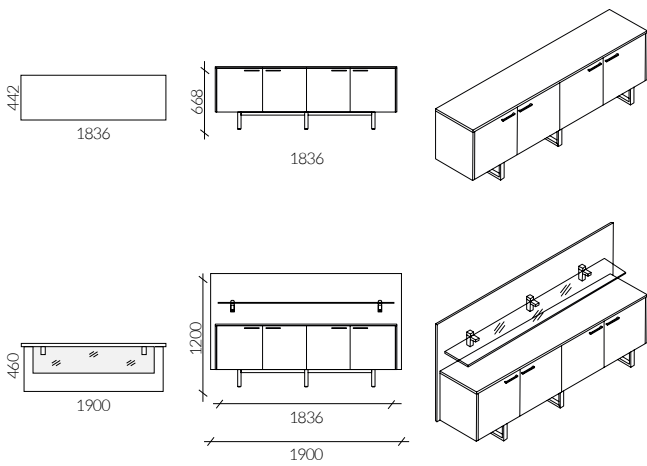

AXY-Line wide executive showcase with open segment

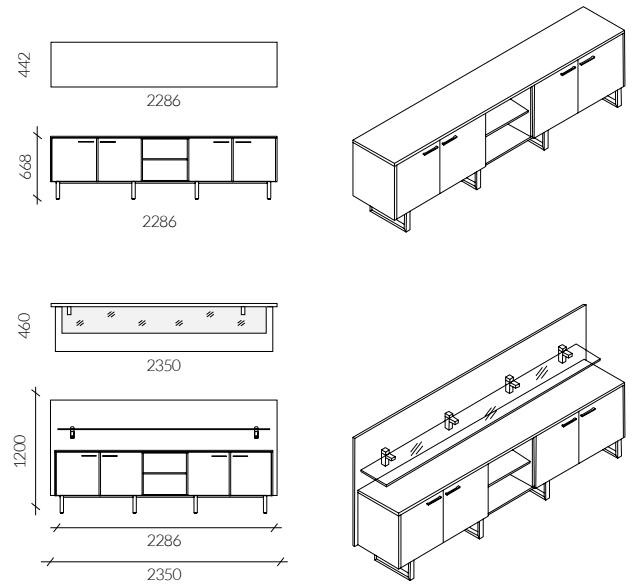

Cabinets

KORPUS

- 18 mm thick board carcass.
- Chipboard coated on both sides with melamine resin with increased durability - 1st class.
- Chipboard with reduced formaldehyde emission, E1 standard.
- Cabinet carcasses are factory-glued, assembled and delivered as a whole.
- Carcass finished with 2 mm thick ABS plastic with 3 mm radius.



AXY-Line low, open cabinet

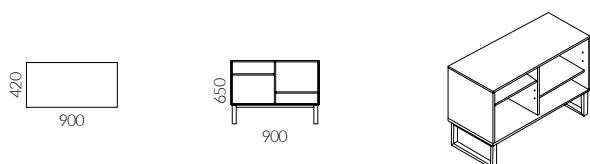

EQUIPMENT

- All shelves are equipped with a mechanism preventing accidental pull out.
- Possibility to manage the space individually thanks to hole spacing (every 32 mm) over the entire height of sides.
- Shelf with Soft Close Automatic mechanism and Push to Open system as standard.
- Hinged doors are equipped with C1 handles as standard. Push to Open system as an option with no surcharge.
- White or graphite decorative inlay between the modules.
- Cabinets are based on 200 mm high, powder-coated legs.
- Cabinets for documents and cabinets for documents and clothes are equipped with powder-coated bases H=30 mm.



BACKWALL

- 8 mm thick back wall recessed into the groove between the sides of the cabinet.
- Back wall is coated on both sides with melamine resin, thanks to which the cabinet can stand independently.

ADDITIONAL INFORMATION

- Colors according to MARO

AXY-Line low, closed cabinet

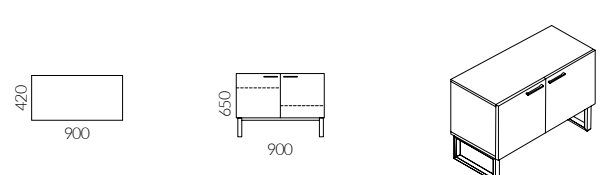

AXY-Line low cabinet with drawer

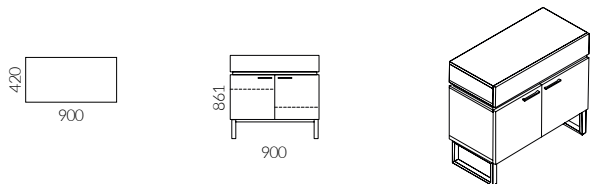

AXY-Line medium cabinet

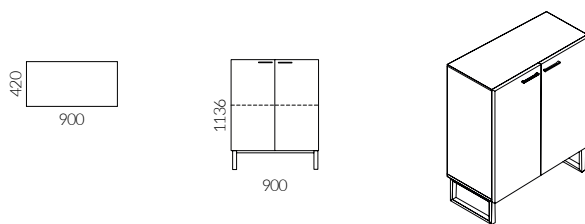

AXY-Line high cabinet with open top segment

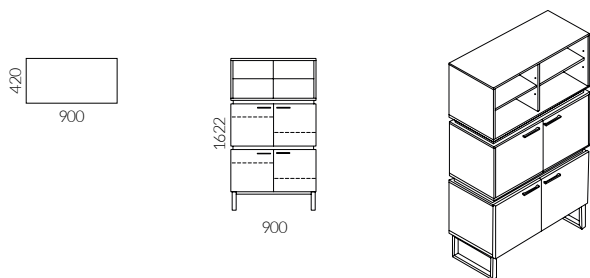

AXY-Line high cabinet with open middle segment

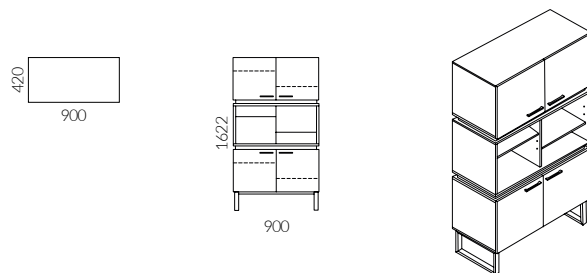

AXY-Line high cabinet

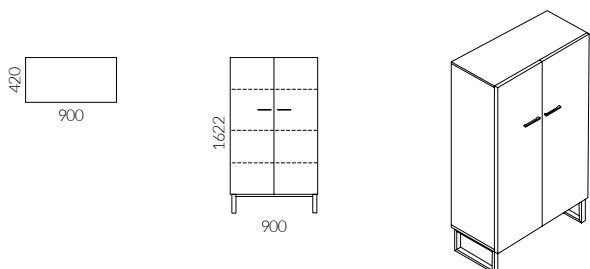

AXY-Line cabinet for documents and clothes

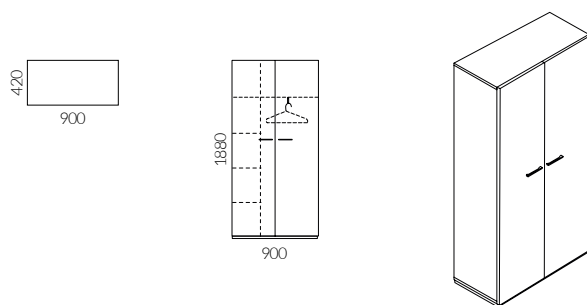

AXY-Line cabinet for documents

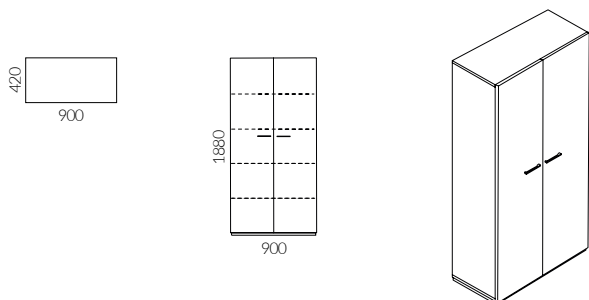

AXY-Line / Features

Cabinets and showcases - details

Shelf

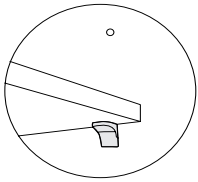

Shelves with a mechanism preventing accidental pull out

Leg

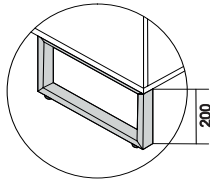

Powder-coated leg

Drawer

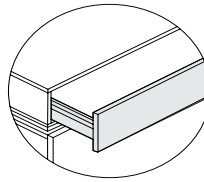

With Soft Close Automatic mechanism and Push to Open system as standard. Graphite drawer interior.

Handle C1

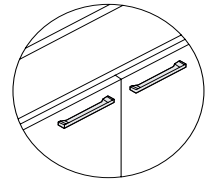

In mat chromium color, 128 mm wide, Push to Open system as an option with no sur charge.

Decorative inlay

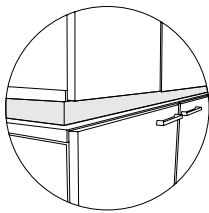

White or graphite decorative inlay

Glass shelf

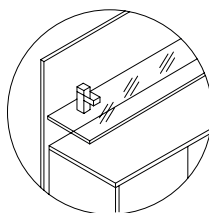

12 mm thick glass shelf for back panel as standard.

Back panel

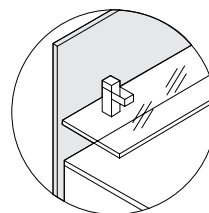

Made of 18 mm thick board d. Possibility to hang a glass shelf

Base

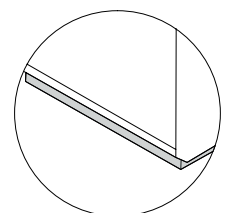

Metal base H= 30 mm

Netbox

Possibility to select and mount a netbox to every AXY-Line table.

ONE-PIECE TOP

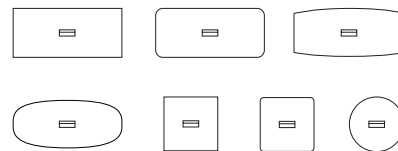
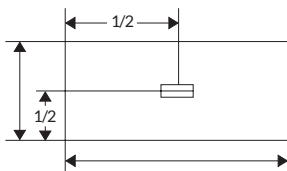

TWO-PIECE TOP

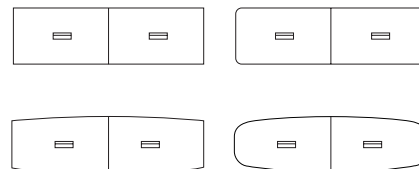
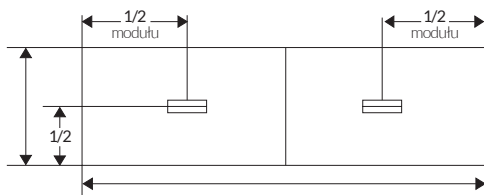

Graining

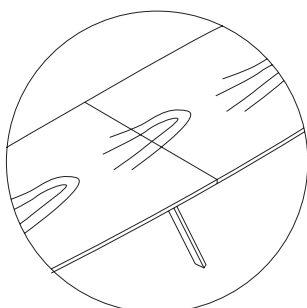

In two-piece tops continuous graining as standard. Minor displacement possible.

Chromium plated feet

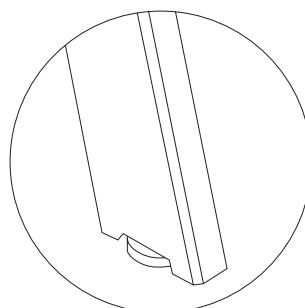

All AXY-Line tables are equipped with chromium plated feet with leveling function + 10 mm.

AXY-Line / Accessories

Horizontal cable management

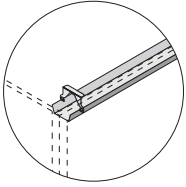

FIXED CABLE CHANNEL

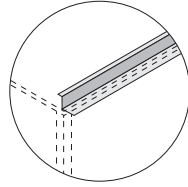

FOLD-DOWN CABLE CHANNEL

DD91

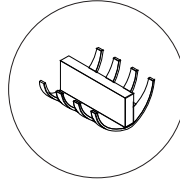

COMB CABLE CLASP

Vertical cable management

UW 14/UW 15

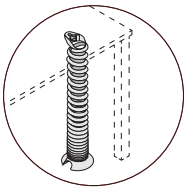

SPRING CABLE CHANNEL

UW 02

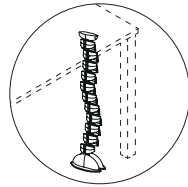

FLEXIBLE CABLE CHANNEL

UW 37/UW 37E

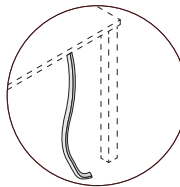

BRAIDED SLEEVE FOR CABLES

Cable outlets

UW 13/ WD01

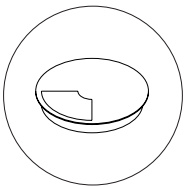

ROUND CABLE OUTLET

UW 28/ UW 281

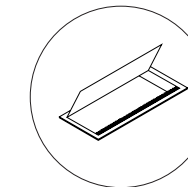

ALUMINUM CABLE OUTLET

Netboxes

UW 36/ UW 35P/
UW 35D/ UW 34P/
UW 34U/ UW 34Da

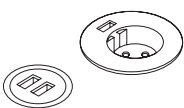

POWER CIRCLE S/M

UW 29/ UW 30/
GD 18/ UW 40/
UW 41/ UW 42

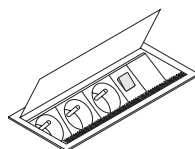

NETBOX

Complementary accessories

US 62 R/L

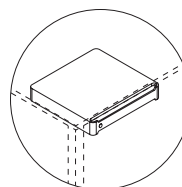

UNDERDESK DRAWER

AXY-Line / Colors

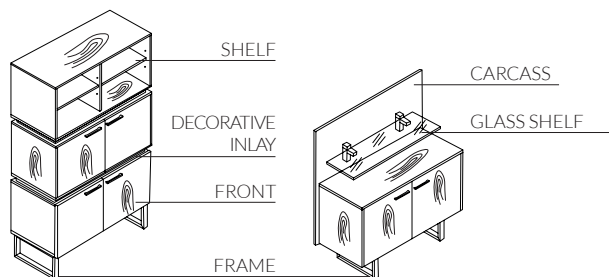

		Top	Mobile table top	Front	Decorative inlay	Carcass	Shelf	Glass shelf
STANDARD	Melamine UNI	STD 1	White	•	•	•	•	•
		STD 2	High Gloss White		•			
		STD 3	Gray	•	•			
		STD 4	Beige	•	•			
		STD 5	Norwegian Green	•	•			
		STD 6	Navy Blue	•	•			
		STD 7	Graphite	•	•	•	•	•
		STD 8	Black	•	•	•	•	•
	Melamine	STD 10	Acacia	•	•	•	•	•
		STD 11	European Maple	•	•	•	•	•
		STD 12	Napolitano Oak	•	•	•	•	•
		STD 13	Gray Spruce	•	•	•	•	•
		STD 14	American Oak	•	•	•	•	•
		STD 15	Natural Oak	•	•	•	•	•
		STD 16	Cherry Havana	•	•	•	•	•
		STD 17	Walnut Brown	•	•	•	•	•
		TREND*	Melamine	TRD 1	Blush		•	•
TRD 2	Claret				•	•	•	
TRD 3	Dark Turquoise				•	•	•	
TRD 11	Stark Oak				•	•	•	
TRD 12	Flamed Oak				•	•	•	
PREMIUM**	HPL	FX1	Fenix Black	•				
		FX2	Fenix White	•				
	Solid wood	RW1	Lacquered Oak	•				
		RW2	Oiled Oak	•				
	Stone	ST 1	Nero Greco	•				
		ST 2	Noir Desir	•				
		ST 3	Bianco Venato	•				
	Veneer	VR 4	Burundi Mahogany	•				
		VR 5	Brazilian Rosewood	•				
		VR 6	Flader Oak	•				
+		Dry-wipe board		•				
STANDARD	Glass	GL01	Opti White			•	•	
		GL02	Satinato					
		GL03	Opti Black			•	•	
		GL04	White Lacobel					
		GL05	Black Lacobel					

		Frame	Leg	Castor	Mobile table leg
STANDARD	Metal	M 02	White	•	•
		M 01	Aluminium	•	•
		M 03	Beige	•	•
		M 04	Black	•	•
		M 05	Graphite	•	•
TREND*	Metal	M 06	Sunny Beige		
		M 07	Faded Turquoise		
		M 08	Ginger		
ABS		M 09	Dirty Pink		
			Black		•

* Panel boards, metals from Trend group and fabrics from 2nd and 3rd groups increase the final price of the product. Detailed information can be found in the table of surcharges on page 376.

** Only 18 mm thick panel boards from trend group available.

** Products in premium colors are priced individually. Information on lead time can be obtained from a sales representative.

Melamine

① STANDARD



② TREND

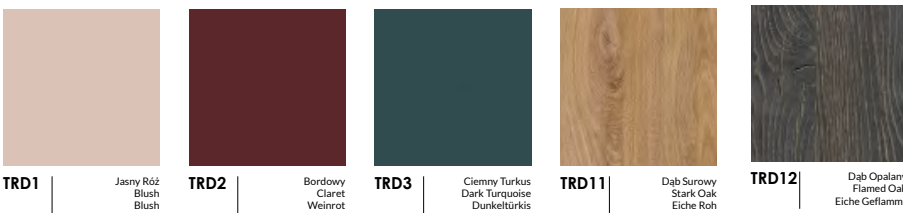

Metal

① STANDARD



② TREND

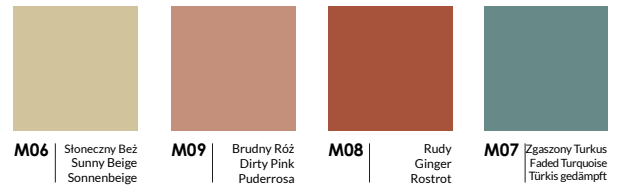

Fabrics

100% Polyester
100.000 Martindale cycles

① CALDO
Select by Lech

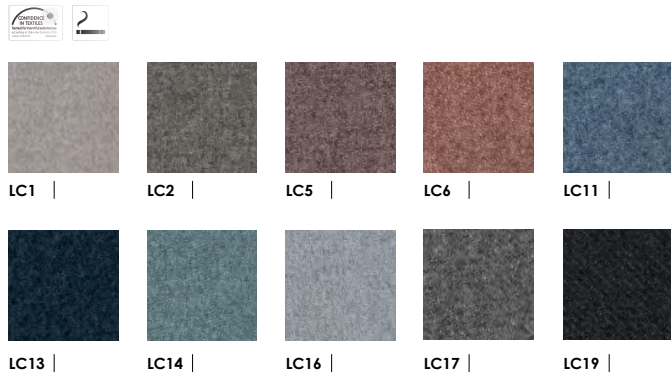

95% Virgin Wool, 5% Poliamid
100.000 Martindale cycles

② SYNERGY
Camira



100% Recycled Polyester
67.000 Martindale cycles

① TERRA
Select by Lech



Information

You can find all our current materials online.

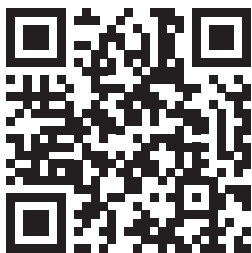

Visit our website maro.pl

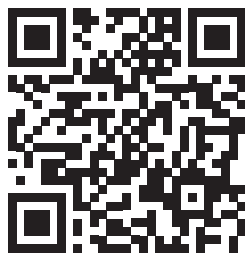

Find high quality photos and films to use in your materials
maro.cloud/photo



Find solids and catalogs
maro.pl/design-tools/pliki-do-pobrania



Order furniture online
shop.maro.pl



Fabryka Mebli Biurowych MARO Sp. z o. o.
PL 62-052 Komorniki, ul. Fabianowska 100

+48 61 890 00 00

maro@maro.pl

MARO.pl

Follow us and join t o MARO community

 [@maroofficefurniture](https://www.linkedin.com/company/maroofficefurniture)

 [@maroofficefurniture](https://www.facebook.com/maroofficefurniture)

 [@maroofficefurniture](https://www.instagram.com/maroofficefurniture)

 [@maroofficefurniture](https://www.youtube.com/maroofficefurniture)

Please place your orders for printed materials and color samples by e-mail t o marketing@maro.pl.

Illustrations presented in this publication are only illustrative and do not constitute any offer or guarantee of any form - it especially applies to presented color and furniture surfaces used by MARO Office Furniture Factory. Please contact MARO sp. z o. o. to obtain information on functions and configurations.

All presented data, especially photos, specifications, descriptions, drawings and technical parameters do not constitute an offer in legal terms of the Civil Code, are not binding and can be changed without prior notice. A Sales Contract contains bidding prices, equipment and specifications.

We reserve the right to make changes and mistakes. All the information in this price list is up-to-date on the publication date/accepting the material for publishing. The prices do not include VAT tax.

General Terms and Conditions of Sales and General Warranty and Complaint Terms and Conditions constitute an integral part of Sales Contracts.

The price list is valid from 01.07.2022 until further notice.