

System-eM / Accessoires

Panneaux de séparation

SIMPLE

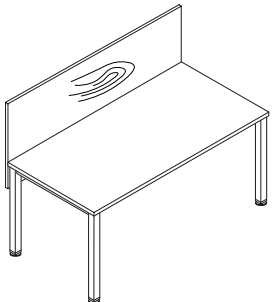

LATÉRAL

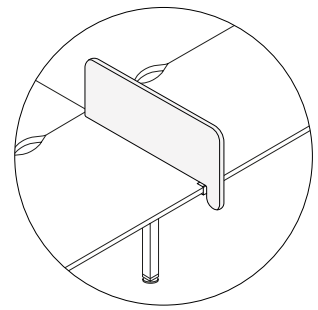

EN TISSU

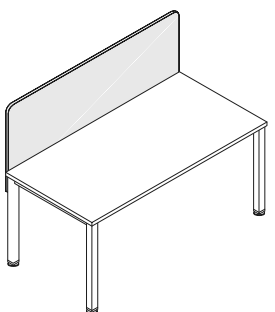

SIMPLE AVEC
PANNEAU EN
TISSU

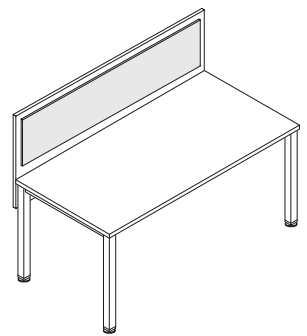

Gestion des câbles horizontale

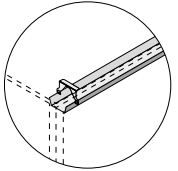
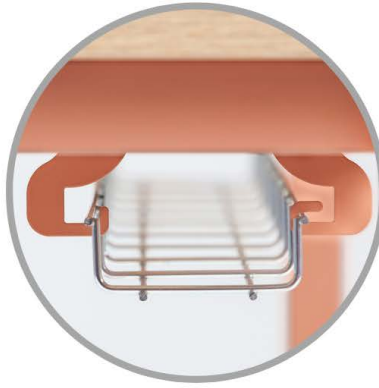

GOULOTTE DE
CÂBLES
INCLINABLE

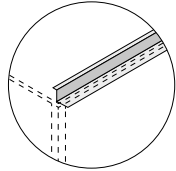

GOULOTTE
DE CÂBLES FIXE

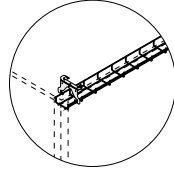

GRILLE PASSE
CÂBLES

DD 91

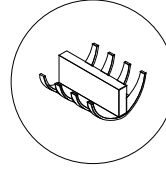

PEIGNE DE CÂBLES

UW 04/ UW 05

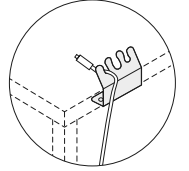

CLIPS DE RANGEMENT

Gestion des câbles verticale



UW 14/ UW 15

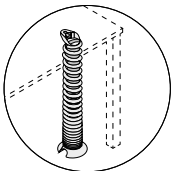

GAINE RANGE-
CÂBLE EN
SPIRALE

UW 02

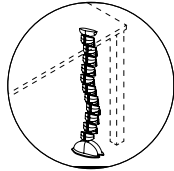

VERTÈBRE PASSE-
CÂBLES

UW 18

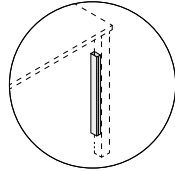

GOULOTTE VERTICALE

UW 10

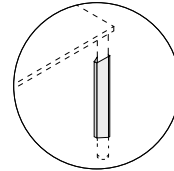

UW 37/ UW 37E

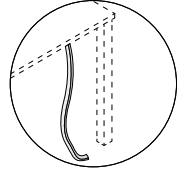

GAINE DE CÂBLE

Passages de câbles



UW 13

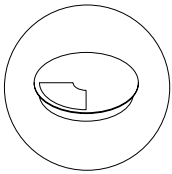

OBTURATEUR



Łezka
UW 16

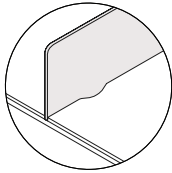

ÉCHANCRURE



Podłużna
UW 17

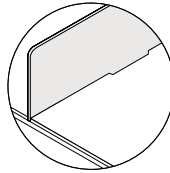

UW 19

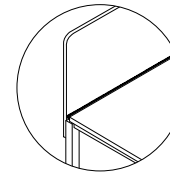

JOINT BROSSÉ

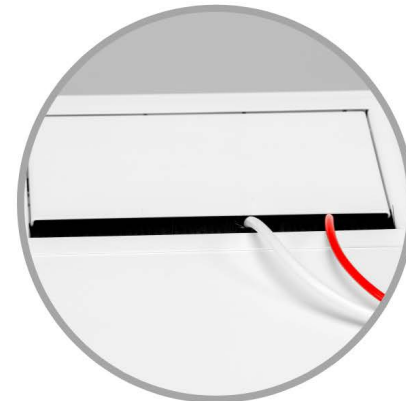

UW 28 / UW 281

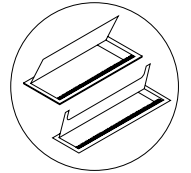

PASSE CÂBLES ALUMINIUM

Voiles de fond et Mediaports pour les bureaux

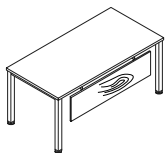

PANNEAU

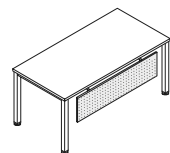
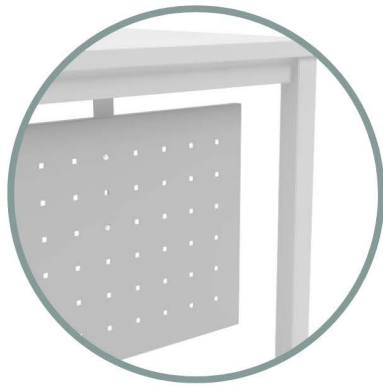

PERFORÉ

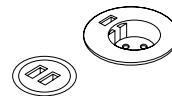

POWER CIRCLE S/M/L

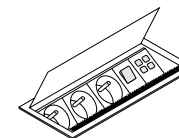

MEDIAPORT

Accessoires complémentaires

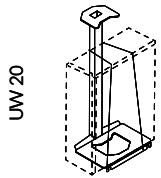

UW 20

SUPPORT
ORDINATEUR

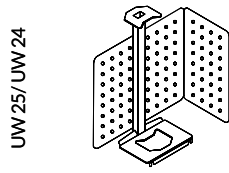

UW 25 / UW 24

SUPPORT ORDINATEUR AVEC
PROTECTION PERFORÉE

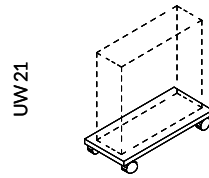

UW 21

SUPPORT ORDINATEUR
AVEC ROULETTES

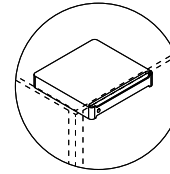

US 62 R/L

TIROIR
SOUS-BUREAU

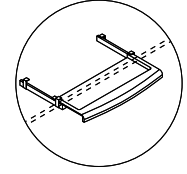

UK 07

TIROIR DE BUREAU
POUR CLAVIER

Panneau de séparation - options

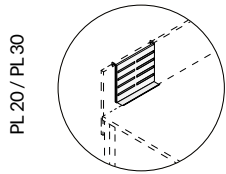

PL 20 / PL 30

TABLEAU
MAGNÉTIQUE
AVEC TABLETTE

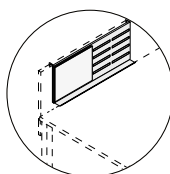

PL 21 / PL 31

PANNEAU EN
TISSU

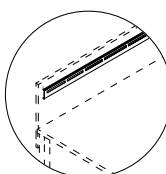

PL 01-07 / PL 964 /
PL 1164

RAIL SUPPORT
ACCESSOIRES

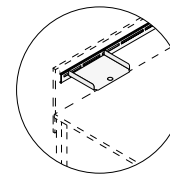
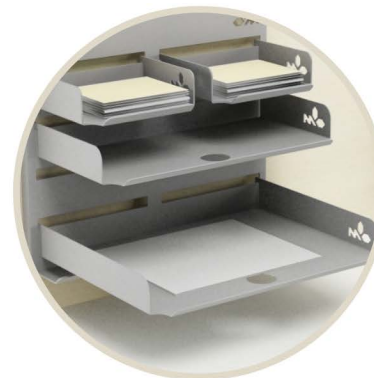

AL 02 / AP 02

TABLETTE EN
MÉTAL A4

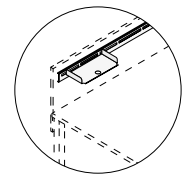

AL 03 / AP 03

TABLETTE EN
MÉTAL C5+



AL04 / AP04

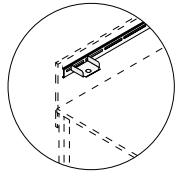

PETITE TABLETTE
EN MÉTAL



AL01 / AP01

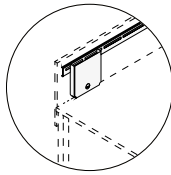

POCHETTE A4
EN MÉTAL
VERTICALE



AL09

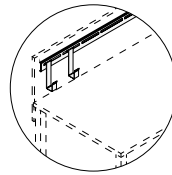

SUPPORT
ORDINATEUR
PORTABLE